

Reel Name	POLE	Width/W	Pitch/P	Width/F	Width/Bo	Qty. pre reel	Reel qty. per carton	Qty. per carton
15EDGRM-THR-3.81-DOUBLE POLE REEL(32)	2	32mm	12mm	14.25mm	18.41mm	470	8	3760
15EDGRM-THR-3.81-SINGLE POLE REEL(56)	3, 5, 7, 9	56mm	12mm	26.25mm	40.2mm	470	5	2350
15EDGRM-THR-3.81-DOUBLE POLE REEL(56)	4, 6, 8	56mm	12mm	26.25mm	40.20mm	470	5	2350
15EDGRM-THR-3.81-REEL(72)	10*13	72mm	16mm	34.25mm	52.9mm	380	3	1140

公差/General Tolerances(mm)													
0	>3	>6	>10	>18	>30	>50	>80	>120	>180	>250	>315	>400	0.170
-	6	10	18	30	50	80	120	180	250	315	400	500	>500
±0.12	±0.18	±0.25	±0.31	±0.37	±0.57	±0.80	±0.93	±1.05	±1.15	±1.60	±2.00	±2.50	±2

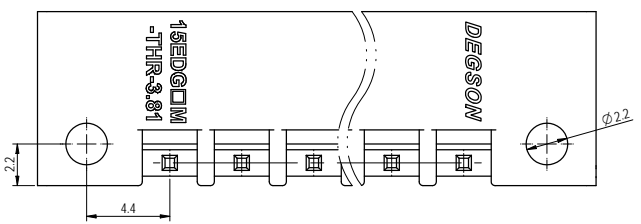
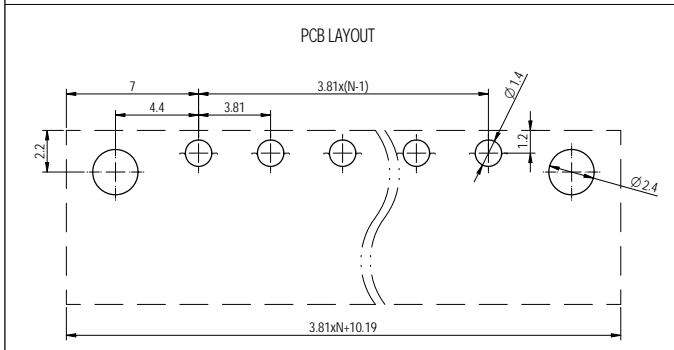
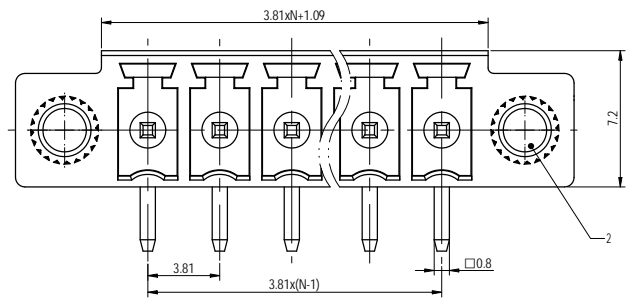
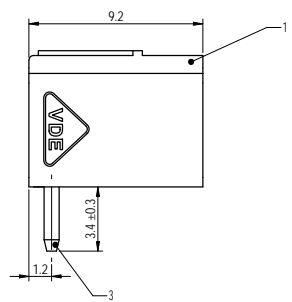
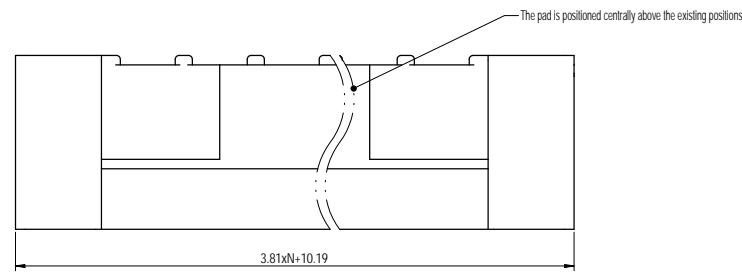
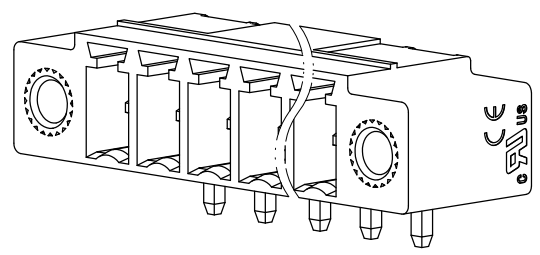
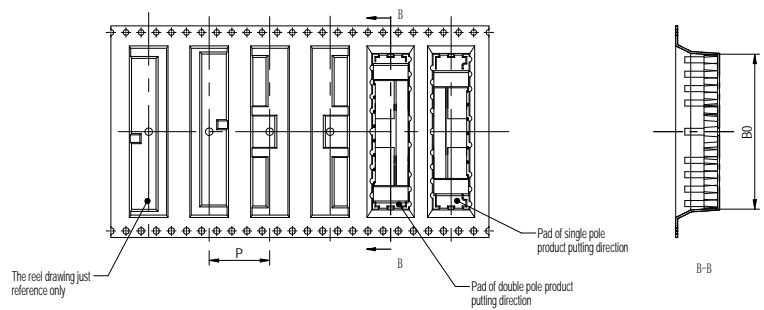
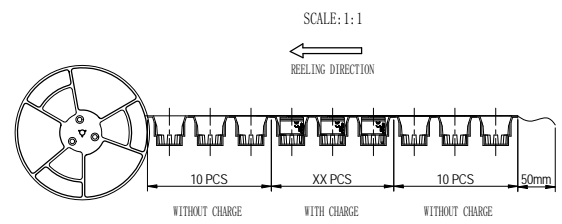

Note:
The A#Z(H) in the name means: A(H) and Z(H).

ITEM	NAME OF PART	MATERIAL	NOTES
3	Pin	Copper	Sn plated
2	Screw cap	Copper alloy	M2.5
1	Housing	Thermoplastic	UL94V-0

UL 标准/UL Standard	B	C	D
额定电压/电压/Rated Voltage(V/Current A)	3008	/	/
IEC 标准/IEC Standard			
额定电压/Overvoltage Category/过压等级/ Pollution Degree	III/3	III/2	II/2
额定电压/电压/Rated Voltage(V/Current A)	/	/	250/8
额定脉冲电压/峰值电压/Rated Voltage(KV/ Peak Impulse Voltage(KV)	/	/	2.5
工作/额定温度/工作温度/Operating temperature(°C)	-40 ~ +130		
符合RoHS环保要求/Conform to RoHS	Yes		

DEGSON

APPRO: 王春华 2023.02.02 NAME: 15EDGRM-THR-3.81-XXP-1Y-00AMZ(H)

CHKD: 李耀宗 2023.02.02

DATE: 200919727 TYPE: CUSTOMER DRAWING

SCALE: 5:1 SHEET: 1/1

Drawing of this product is for reference only. The actual product shall be confirmed with the manufacturer. The manufacturer shall be responsible for the accuracy of the drawing. The user shall be responsible for the accuracy of the drawing. The manufacturer shall be responsible for the accuracy of the drawing. The user shall be responsible for the accuracy of the drawing.